













ASSEMBLY INSTRUCTION

PARTS LIST

Part No.	Photo	Part name	QTY
1		Table top	1pc
2		Seat top	2pcs
3		Legs	4pcs
4		Down Cross bar	2pcs
5		Up Cross bar	2pcs
6		Table supporter	2pcs
7		Long bolts	28pcs
8		Short bolts	8pcs
9		Washers	72pcs
10		Nuts	36pcs
11		Screws	4pcs
12		Seat supporter	4pcs
13		Wrench	1pc

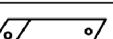
Fix photo

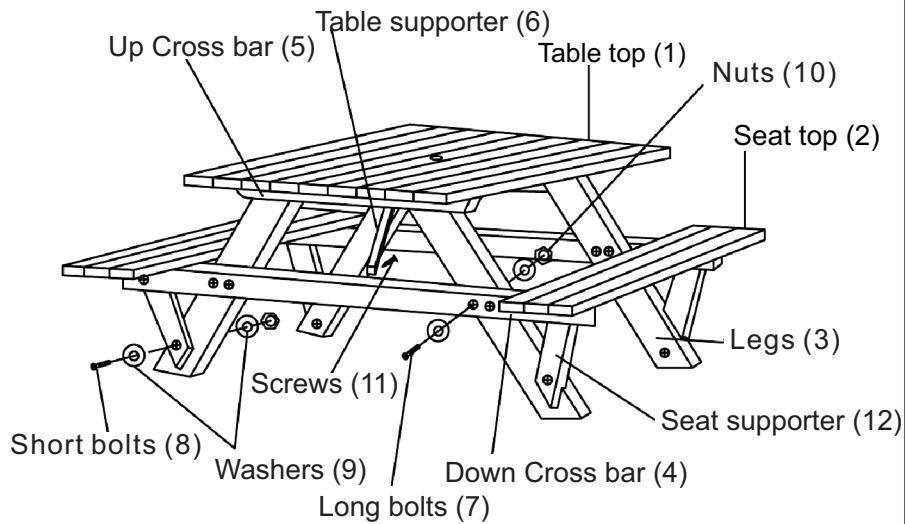

STEP 1

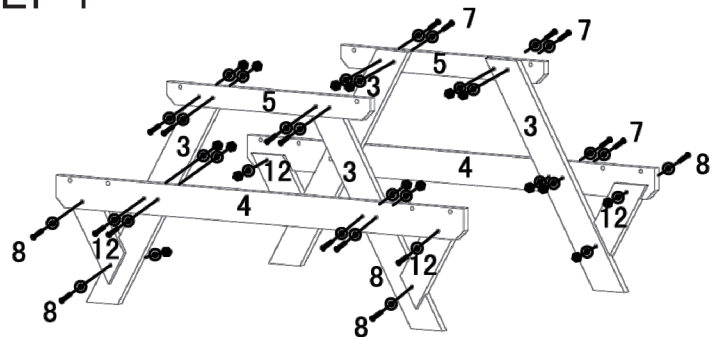

STEP 2

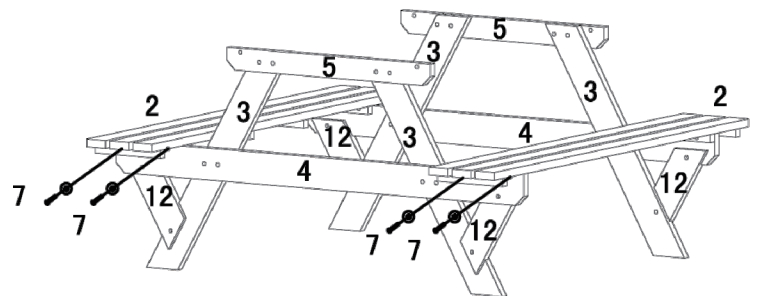

STEP 3

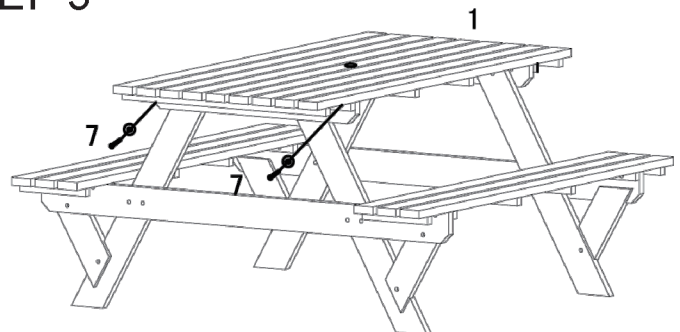

STEP 4

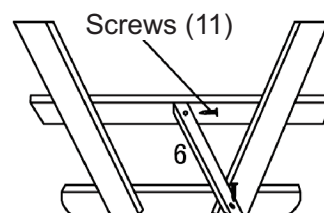

Tips for fixing .

- ※Checking all parts if included before fixing.
- ※Do not fasten screws and bolts before last step.
- ※Recommend two people to fix it .

STEP 1 .

Fix the up cross bar (5) and down cross bar (4) to the table leg (3) ,by using 16 sets long bolts and washers .Connect the Seat supporter (12)to table leg (3) and Down Cross bar (4),use 8sets short bolts and washers and nuts .

STEP 2 .

Fix the seat (2) to above finished frame ,use 8 sets long bolts and washers and nuts .

STEP 3 .

Fix the table top (1) to above finished frame,use 4 sets long bolts and washers and nuts .

STEP 4 .

Fasten all bolts and nuts. Turn down the table to fix the table supporter (6),use 4 pcs screws . Turn up the beer table for use .