





PART LIST

A		4pcs	B		12pcs	C		12pcs
D		2pcs	E		4pcs			



Side Frames



Bottom Bars



Top bar



Bottom Plate



Back Plate



Straight Pole



Tool Set



Wheels

STEP1: Connect one side frame with two bottom bars by screws A.

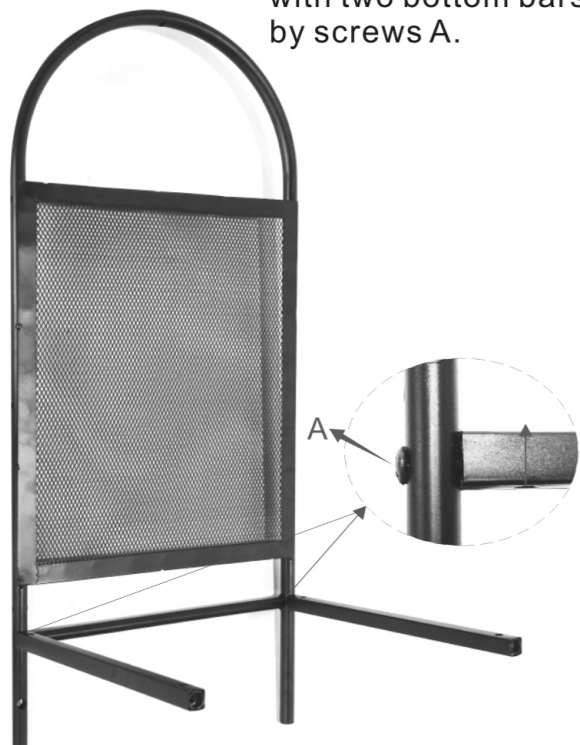

STEP2: Put the bottom plate on the bottom bars fix by screw B and nut C.

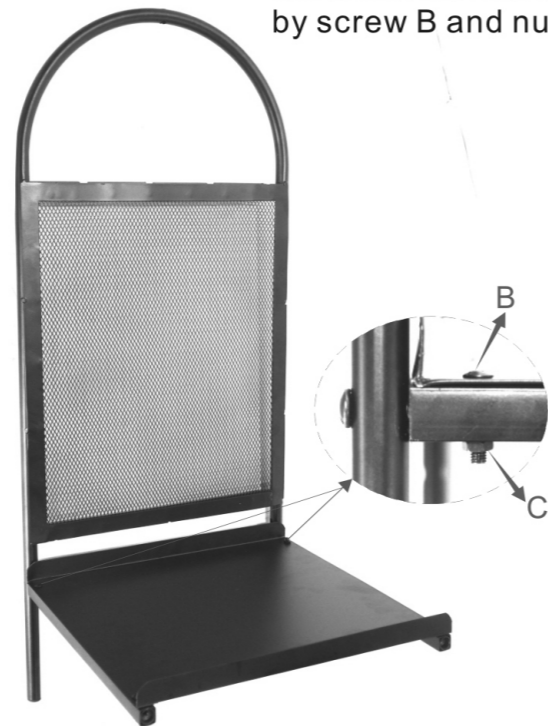

STEP3: Assembly the another side frame to the bottom bars by screws A.



STEP4: Fix the back plate to the side frames by screws B and nut C.



STEP5: Let the straight pole through the hole on the bottom of side frame, fix the wheels by washer E and nut D, Then fix the top bar by screws B and nut C.

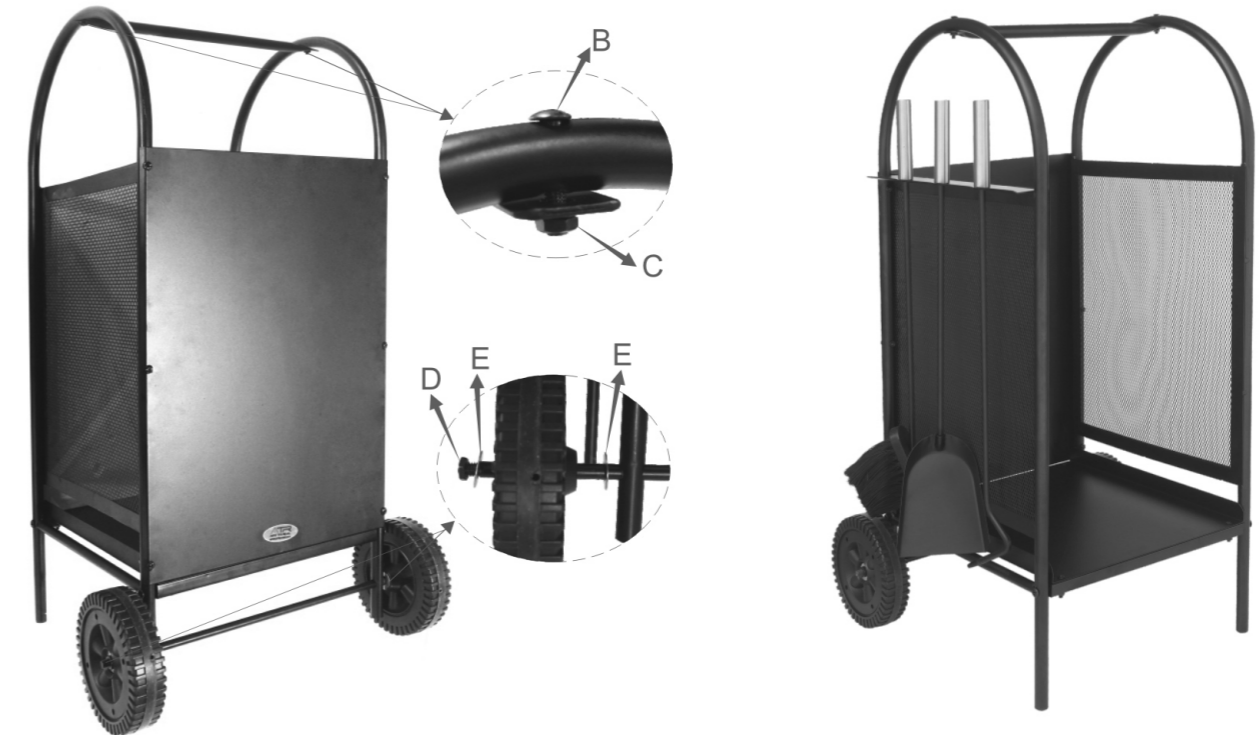

Tips: All the screws can't screw too tight at first, when all the accessories assembled, then tight them, or maybe some holes can not match.